



Owner's Manual

Radiant Slide-In Ranges

Model: CES700P

Contents

Safety Information	3	Care And Cleaning	
Using the Range		Cleaning the Range – Exterior	21
Surface Units	8	Cleaning the Range – Interior	22
Oven Controls	12	Cleaning the Glass Cooktop	23
Options	13	Oven Probe	24
Settings	13	Drawer	25
Sabbath Mode	15	Oven Light	26
Oven Racks	16	Oven Door	26
Aluminum Foil and Oven Liners	17	Troubleshooting Tips	27
Cookware	17	Limited Warranty	30
Cooking Modes	17	Accessories	31
Oven Probe	19	Consumer Support	32
Cooking Guide	20		

Write the model and serial numbers here:

Model # _____

Serial # _____

You can find the rating label on the front behind the range drawer.

Español

Para consultar una version en español de este manual de instrucciones, visite nuestro sitio de internet cafeappliances.com.

THANK YOU FOR MAKING CAFÉ A PART OF YOUR HOME.

We take pride in the craftsmanship, innovation and design that goes into every Café product, and we think you will too. Among other things, registration of your appliance ensures that we can deliver important product information and warranty details when you need them.

Register your Café appliance now online. Helpful websites are available in the Consumer Support section of this Owner's Manual. You may also mail in the pre-printed registration card included in the packing material.

C A F É

IMPORTANT SAFETY INFORMATION

READ ALL INSTRUCTIONS BEFORE USING THE APPLIANCE

▲WARNING Read all safety instructions before using the product. Failure to follow these instructions may result in fire, electrical shock, serious injury or death.

ANTI-TIP DEVICE

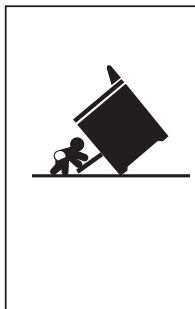

▲WARNING

Tip-Over Hazard

- A child or adult can tip the range and be killed.
- Install the anti-tip bracket to the wall or floor.
- Engage the range to the anti-tip bracket by sliding the range back such that the foot is engaged.
- Re-engage the anti-tip bracket if the range is moved.
- Failure to do so can result in death or serious burns to children or adults.

To reduce the risk of tipping the range, the range must be secured by a properly installed anti-tip bracket. See installation instructions shipped with the bracket for complete details before attempting to install.

For Free-Standing and Slide-In Ranges

To check if the bracket is installed and engaged properly, look underneath the range to see that the rear leveling leg is

engaged in the bracket. On some models, the storage drawer or kick panel can be removed for easy inspection. If visual inspection is not possible, slide the range forward, confirm the anti-tip bracket is securely attached to the floor or wall, and slide the range back so the rear leveling leg is under the anti-tip bracket.

If the range is pulled from the wall for any reason, always repeat this procedure to verify the range is properly secured by the anti-tip bracket.

Never completely remove the leveling legs or the range will not be secured to the anti-tip device properly.

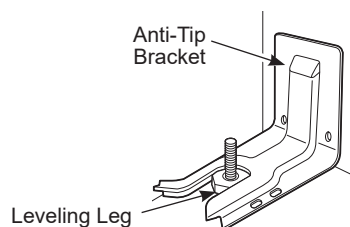

Free-Standing and Slide-In Ranges

▲WARNING GENERAL SAFETY INSTRUCTIONS

- Before performing any service, unplug the range or disconnect the power supply at the household distribution panel by removing the fuse or switching off the circuit breaker.
- Do not leave children alone—children should not be left alone or unattended in an area where an appliance is in use. They should never be allowed to climb, sit or stand on any part of the appliance.
- **▲CAUTION** Do not store items of interest to children above a range or on the backguard of a range—children climbing on the range to reach items could be seriously injured.
- Use only dry pot holders—moist or damp pot holders on hot surfaces may result in burns from steam. Do not let pot holders touch hot surface units or heating elements. Do not use a towel or other bulky cloth in place of pot holders.
- Never use your appliance for warming or heating the room.
- Do not touch the surface units, the heating elements or the interior surface of the oven. These surfaces may be hot enough to burn even though they are dark in color. During and after use, do not touch, or let clothing or other flammable materials contact the surface units, areas nearby the surface units or any interior area of the oven; allow sufficient time for cooling first. Other surfaces of the appliance may become hot enough to cause burns. Potentially hot surfaces include the cooktop, areas facing the cooktop, oven vent opening, surfaces near the opening and crevices around the oven door.
- Do not heat unopened food containers. Pressure could build up and the container could burst, causing an injury.
- Do not use any type of foil or liner to cover the oven bottom or anywhere in the oven, except as described in this manual. Oven liners can trap heat or melt, resulting in damage to the product and risk of shock, smoke or fire.
- Avoid scratching or impacting glass doors, cook tops or control panels. Doing so may lead to glass breakage. Do not cook on a product with broken glass. Shock, fire or cuts may occur.
- Cook meat and poultry thoroughly—meat to at least an internal temperature of 160°F and poultry to at least an internal temperature of 180°F. Cooking to these temperatures usually protects against foodborne illness.

READ AND SAVE THESE INSTRUCTIONS

IMPORTANT SAFETY INFORMATION

READ ALL INSTRUCTIONS BEFORE USING THE APPLIANCE

▲WARNING KEEP FLAMMABLE MATERIALS AWAY FROM THE RANGE

Failure to do so may result in fire or personal injury.

- Do not store or use flammable materials in an oven or near the cooktop, including paper, plastic, pot holders, linens, wall coverings, curtains, drapes and gasoline or other flammable vapors and liquids.
- Never wear loose-fitting or hanging garments while using the appliance. These garments may ignite if they contact hot surfaces causing severe burns.
- Do not let cooking grease or other flammable materials accumulate in or near the range. Grease in the oven or on the cooktop may ignite.
- Clean ventilating hoods frequently. Grease should not be allowed to accumulate on the hood or filter.

▲WARNING IN THE EVENT OF A FIRE, TAKE THE FOLLOWING STEPS TO PREVENT INJURY AND FIRE SPREADING

- Do not use water on grease fires. Never pick up a flaming pan. Turn the controls off. Smother a flaming pan on a surface unit by covering the pan completely with a well-fitting lid, cookie sheet or flat tray. Use a multi-purpose dry chemical or foam-type fire extinguisher.
- If there is a fire in the oven during baking, smother the fire by closing the oven door and turning the oven off or by using a multi-purpose dry chemical or foam-type fire extinguisher.
- If there is a fire in the oven during self-clean, turn the oven off and wait for the fire to go out. Do not force the door open. Introduction of fresh air at self-clean temperatures may lead to a burst of flame from the oven. Failure to follow this instruction may result in severe burns.

▲WARNING COOKTOP SAFETY INSTRUCTIONS

- Never leave the surface units unattended at medium or high heat settings. Boilovers cause smoking and greasy spillovers that may catch on fire.
- Never leave oil unattended while frying. If allowed to heat beyond its smoking point, oil may ignite resulting in fire that may spread to surrounding cabinets. Use a deep fat thermometer whenever possible to monitor oil temperature.
- To avoid oil spillover and fire, use a minimum amount of oil when shallow pan-frying and avoid cooking frozen foods with excessive amounts of ice.
- Only certain types of glass, glass/ceramic, earthenware or other glazed containers are suitable for cooktop service; others may break because of the sudden change in temperature.
- To minimize the possibility of burns, ignition of flammable materials and spillage, the handle of a container should be turned toward the center of the range without extending over nearby surface units.
- When preparing flaming foods under a hood, turn the fan on.

READ AND SAVE THESE INSTRUCTIONS

IMPORTANT SAFETY INFORMATION

READ ALL INSTRUCTIONS BEFORE USING THE APPLIANCE

▲WARNING GLASS COOKTOP SAFETY INSTRUCTIONS

- Use care when touching the cooktop. The glass surface of the cooktop will retain heat after the controls have been turned off.
- Do not cook on a broken cooktop. If glass cooktop should break, cleaning solutions and spillovers may penetrate the broken cooktop and create a risk of electric shock. Contact a qualified technician immediately.
- Avoid scratching the glass cooktop. The cooktop can be scratched with items such as knives, sharp instruments, rings or other jewelry, and rivets on clothing.
- Use CERAMA BRYTE® ceramic Cooktop Cleaner and CERAMA BRYTE® Cleaning Pad to clean the cooktop. Wait until the cooktop cools and the indicator light goes out before cleaning. A wet sponge or cloth on a hot surface can cause steam burns. Some cleaners can produce noxious fumes if applied to a hot surface. **NOTE:** Sugar spills are an exception. They should be scraped off while still hot using an oven mitt and a scraper. See the Cleaning the glass cooktop section for detailed instructions.
- Read and follow all instructions and warnings on the cleaning cream label.
- Do not place or store items that can melt or catch fire on the glass cooktop, even when it is not being used. If the cooktop is inadvertently turned on, they may ignite. Heat from the cooktop or oven vent after it is turned off may cause them to ignite also.
- Do not place metallic objects such as knives, forks, spoons and lids on the cooktop surface since they can get hot.

▲WARNING OVEN SAFETY INSTRUCTIONS

- Stand away from the range when opening the oven door. Hot air or steam which escapes can cause burns to hands, face and/or eyes.
- Do not use the oven if a heating element develops a glowing spot during use or shows other signs of damage. A glowing spot indicates the heating element may fail and present a potential burn, fire, or shock hazard. Turn the oven off immediately and have the heating element replaced by a qualified service technician.
- Keep the oven vent unobstructed.
- Keep the oven free from grease buildup. Grease in the oven may ignite.
- Place oven racks in desired location while oven is cool. If rack must be moved while oven is hot, do not let pot holder contact hot heating element in oven.
- When using cooking or roasting bags in the oven, follow the manufacturer's directions.
- Pull the oven rack to the stop-lock position when loading and unloading food from the oven. This helps prevent burns from touching hot surfaces of the door and oven walls.
- Do not leave items such as paper, cooking utensils or food in the oven when not in use. Items stored in an oven can ignite.
- Never place cooking utensils, pizza or baking stones, or any type of foil or liner on the oven floor. These items can trap heat or melt, resulting in damage to the product and risk of shock, smoke or fire.

READ AND SAVE THESE INSTRUCTIONS

IMPORTANT SAFETY INFORMATION

READ ALL INSTRUCTIONS BEFORE USING THE APPLIANCE

▲WARNING SELF-CLEANING OVEN SAFETY INSTRUCTIONS

The self-cleaning feature operates the oven at temperatures high enough to burn away food soils in the oven. Follow these instructions for safe operation.

- Do not touch oven surfaces during self-clean operation. Keep children away from the oven during self-cleaning. Failure to follow these instructions may cause burns.
- Before operating the self-clean cycle, remove pans, shiny metal oven racks and other utensils from the oven. Only gray porcelain-coated oven racks may be left in the oven. Do not use self-clean to clean other parts, such as drip pans or bowls.
- Before operating the self-clean cycle, wipe grease and food soils from the oven. Excessive amount of grease may ignite leading to smoke damage to your home.
- If the self-cleaning mode malfunctions, turn the oven off and disconnect the power supply. Have it serviced by a qualified technician.
- Do not clean the door gasket. The door gasket is essential for a good seal. Care should be taken not to rub, damage or move the gasket.
- Do not use oven cleaners. No commercial oven cleaner or oven liner protective coating of any kind should be used in or around any part of the oven.

▲WARNING WARMING DRAWER SAFETY INSTRUCTIONS

- The purpose of the warming drawer is to hold hot cooked foods at serving temperature. Bacteria will grow in food while it is below 140°F. Do not put cold food in warming drawer. Do not heat food for more than 2 hours. Failure to follow these instructions may result in foodborne illness.
- Do not leave paper products, plastics, canned food or combustible materials in the drawer. They may ignite.
- Do not touch the heating element or the interior surface of the drawer. These surfaces may be hot enough to cause burns.
- Use care when opening the drawer. Open the drawer a crack and let hot air or steam escape before removing or replacing food. Hot air or steam that escapes can cause burns to hands, face and/or eyes.
- Do not use aluminum foil to line the lower drawer. The foil will trap heat below, and upset the performance of the oven. Foil can melt and permanently damage the drawer bottom. Damage from improper use of aluminum foil is not covered by the product warranty.

READ AND SAVE THESE INSTRUCTIONS

IMPORTANT SAFETY INFORMATION

READ ALL INSTRUCTIONS BEFORE USING THE APPLIANCE

Remote Enable Equipment

This device complies with part 15 of the FCC Rules. Operation is subject to the following two conditions: (1) This device may not cause harmful interference, and (2) this device must accept any interference received, including interference that may cause undesired operation.

The wireless communication equipment installed on this range has been tested and found to comply with the limits for a Class B digital device, pursuant to part 15 of the FCC Rules. These limits are designed to:

(a) provide reasonable protection against harmful interference in a residential installation. This equipment generates, uses, and can radiate radio frequency energy and, if not installed and used in accordance with the instructions, may cause harmful interference to radio communications. However, there is no guarantee that interference will not occur in a particular installation. If this equipment does cause harmful interference to radio or television reception, which can be determined by

turning the equipment off and on, the user is encouraged to try to correct the interference by one or more of the following measures:

- Reorient or relocate the receiving antenna.
- Increase the separation between the equipment and receiver.
- Connect the equipment into an outlet on a circuit different from that to which the receiver is connected.
- Consult the dealer or an experienced radio/TV technician for help.

(b) accept any interference received, including interference that may cause undesired operation of the device.

Note that any changes or modifications to the wireless communication device installed on this oven that are not expressly approved by the manufacturer could void the user's authority to operate the equipment.

How to Remove Protective Shipping Film and Packaging Tape

Carefully grasp a corner of the protective shipping film with your fingers and slowly peel it from the appliance surface. Do not use any sharp items to remove the film. Remove all of the film before using the appliance for the first time.

To assure no damage is done to the finish of the product, the safest way to remove the adhesive from packaging tape on new appliances is an application of a household liquid dishwashing detergent. Apply with a soft cloth and allow to soak.

NOTE: The adhesive must be removed from all parts. It cannot be removed if it is baked on.

READ AND SAVE THESE INSTRUCTIONS

Surface Units

Operating the Cooktop Elements

▲ WARNING **FIRE HAZARD:** Never leave the range unattended with the cooktop on medium or high settings. Keep flammable items away from the cooktop. Turn off all controls when done cooking. Failure to follow these instructions can result in fire, serious injury or death.

Before using the cooktop for the first time, clean it with CERAMA BRYTE® Ceramic Cooktop Cleaner. This helps protect the top and makes cleanup easier.

Throughout this manual, features and appearance may vary from your model.

Push the knob in and turn in either direction to the setting you want.

A knob indicator light will glow when any surface unit is on.

For glass cooktop surfaces:

A **HOT COOKTOP** indicator light will:

- come on when the unit is hot to the touch.
- stay on even after the unit is turned off.
- stay on until the unit is cooled to approximately 150°F.

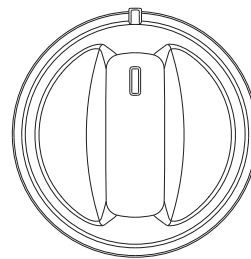

At both **OFF** and **HI** the control clicks into position. You may hear slight clicking sounds during cooking, indicating the control is maintaining your desired setting.

Be sure you turn the control knob to **OFF** when you finish cooking.

Using the Warming Zone (on some models)

▲ WARNING

FOOD POISON HAZARD: Bacteria may grow in food at temperatures below 140°F.

- Always start with hot food. Do not use warm setting to heat cold food.
- Do not use warm setting for more than 2 hours.

The **WARMING ZONE**, located in the back center of the glass surface, will keep hot, cooked food at serving temperature. Always start with hot food. Do not use to heat cold food. Placing uncooked or cold food on the **WARMING ZONE** could result in foodborne illness.

To turn the **WARMING ZONE** on, turn knob clockwise to the setting you want.

For best results, all foods on the **WARMING ZONE** should be covered with a lid or aluminum foil. When warming pastries or breads, the cover should be vented to allow moisture to escape.

The initial temperature, type and amount of food, type of pan, and the time held will affect the quality of the food.

Always use pot holders or oven mitts when removing food from the **WARMING ZONE**, since cookware and plates will be hot.

Surface Units (Cont.)

Radiant Glass Cooktop

The radiant cooktop features heating units beneath a smooth glass surface.

NOTE: A slight odor is normal when a new cooktop is used for the first time. It is caused by the heating of new parts and insulating materials and will disappear in a short time.

NOTE: On models with light-colored glass cooktops, it is normal for the cooking zones to change color when hot or cooling down. This is temporary and will disappear as the glass cools to room temperature.

The surface unit will cycle on and off to maintain your selected control setting.

It is safe to place hot cookware on the glass surface even when the cooktop is cool.

Even after the surface units are turned off, the glass cooktop retains enough heat to continue cooking. To avoid overcooking, remove pans from the surface units when the food is cooked. Avoid placing anything on the surface unit until it has cooled completely.

- Water stains (mineral deposits) are removable using the cleaning cream or full-strength white vinegar.
- Use of window cleaner may leave an iridescent film on the cooktop. The cleaning cream will remove this film.
- Don't store heavy items above the cooktop. If they drop onto the cooktop, they can cause damage.
- Do not use the surface as a cutting board.



Never cook directly on the glass. Always use cookware.



Always place the pan in the center of the surface unit you are cooking on.



Do not slide cookware across the cooktop because it can scratch the glass—the glass is scratch-resistant, not scratch proof.

Temperature Limiter on Radiant Glass Cooktops

Every radiant surface unit has a temperature limiter.

The temperature limiter protects the glass cooktop from getting too hot.

The temperature limiter may cycle the surface units off for a time if:

- the pan boils dry.
- the pan bottom is not flat.
- the pan is off-center.
- there is no pan on the unit.

Surface Units (Cont.)

Cookware for Radiant Glass Cooktops

The following information will help you choose cookware which will give good performance on glass cooktops.

NOTE: Follow all cookware manufacturer's recommendations when using any type of cookware on the ceramic cooktop.

Recommended

Stainless Steel

Aluminum

Heavy weight recommended.

Good conductivity. Aluminum residues sometimes appear as scratches on the cooktop but can be removed if cleaned immediately. Because of its low melting point, thin weight aluminum should not be used.

Copper Bottom

Copper may leave residues which can appear as scratches. The residues can be removed, as long as the cooktop is cleaned immediately. However, do not let these pots boil dry. Overheated metal can bond to glass cooktops. An overheated copper bottom pot will leave a residue that will permanently stain the cooktop if not removed immediately.

Enamel (painted) on Cast Iron

Recommended if bottom of pan is coated.

Avoid/Not Recommended

Enamel (painted) on Steel

Heating empty pans can cause permanent damage to cooktop glass. The enamel can melt and bond to the ceramic cooktop.

Glass-ceramic

Poor performance. Will scratch the surface.

Stoneware

Poor performance. May scratch the surface.

Cast Iron

Not recommended—unless designed specifically for glass cooktops.

Poor conductivity and slow to absorb heat. Will scratch the cooktop surface.

Surface Units (Cont.)

More about Cookware

- Place only dry pans on the surface elements. Do not place lids on the surface elements, particularly wet lids. Wet pans and lids may stick to smooth surface when cool.
- Do not use woks that have support rings. This type of wok will not heat on the cooktop.
- We recommend that you use only a flat-bottomed wok. They are available at your local retail store. The bottom of the wok should have the same diameter as the surface element to ensure proper contact.
- Some special cooking procedures require specific cookware such as pressure cookers or deep-fat fryers. All cookware must have flat bottoms and be the correct size.

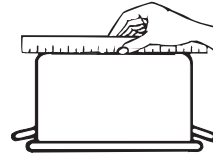

Check pans for flat bottoms by using a straight edge. You should not be able to pass a US nickel coin under the straight edge.



Do not place wet pans on the glass cooktop.



Pans with rounded, curved, ridged or warped bottoms are not recommended.



Do not use woks with support rings on the glass cooktop.



Use flat-bottomed woks on the glass cooktop.

Home Canning Tips

Be sure the canner is centered over the surface unit.

Make sure the canner is flat on the bottom.

To prevent burns from steam or heat, use caution when canning.

Use recipes and procedures from reputable sources. These are available from manufacturers such as Ball® and Kerr® and the Department of Agriculture Extension Service.

Flat-bottomed canners are recommended. Use of water bath canners with rippled bottoms may extend the time required to bring the water to a boil.

Oven Controls

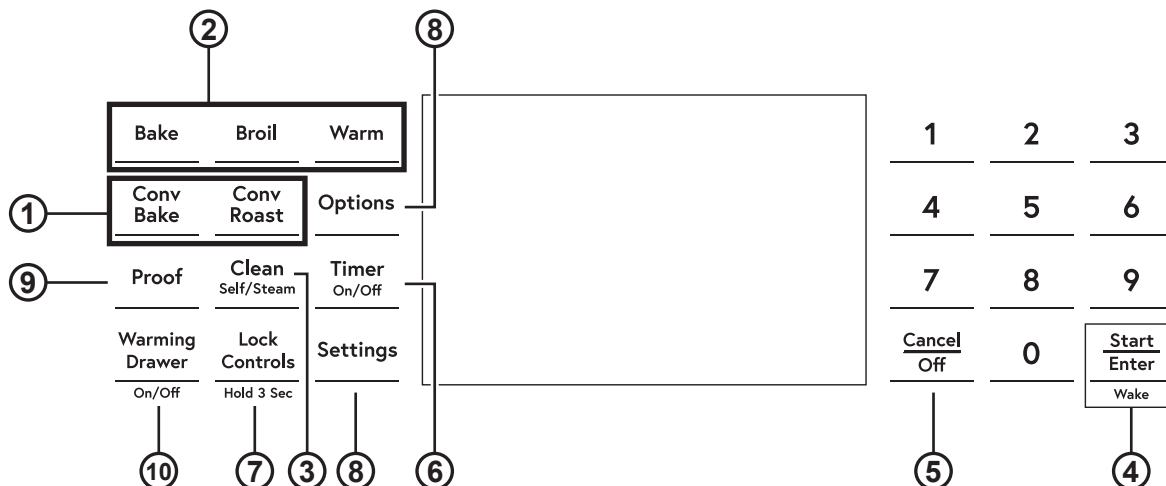

- 1. Convection Cooking Modes:** Convection cooking mode uses increased air circulation to improve performance. See the Cooking Modes section for more information.
 - 2. Traditional Cooking Modes:** Your oven has the following traditional cooking modes: Bake and Broil. See the Cooking Modes section for more information.
 - 3. Clean:** Your oven has two cleaning modes: Self Clean and Steam Clean. See the Cleaning the Oven section for important information about using these modes.
 - 4. Start/Enter:** Must be pressed to start any cooking, cleaning, or timed function.
 - 5. Cancel/Off:** Cancels ALL oven operations except the clock, timer and warming drawer.
 - 6. Timer:** Works as a countdown timer. Press the **Timer** pad and use the number pads to program the time in hours and minutes. Press the **Start/Enter** pad. The oven will continue to operate when the timer countdown is complete. To turn the timer off, press the **Timer** pad.
 - 7. Lock Controls:** Locks out the control so that pressing the pads does not activate the controls. Press the **Lock Controls** pad, for three seconds to lock or unlock the control. **Cancel/Off** is always active, even when the control is locked.
 - 8. Options and Settings:** The Options and Settings pads open up more detailed menus in the display that allow access to additional functions and cooking modes. For each you select the function in the display using the associated number pad. You can exit at any time by pressing the **Options** or **Settings** pad again. See the Settings, Options, and Cooking Modes Sections for more details.
 - 9. Proof:** Proof mode maintains a warm environment for rising yeast-leavened dough. If the oven is too warm, Proof mode will not operate and the display will show "Oven too hot for Proof". For best results, cover the dough while proofing and check early to avoid over-proofing.
- ⚠ CAUTION** Do not use the Proof mode for warming food or keeping food hot. The proofing oven temperature is not hot enough to hold foods at safe temperatures.
- 10. Warming Drawer:** Will keep hot, cooked foods at serving temperature. See the Cooking Modes section for more information.

Options

The options pad opens up a menu of more cooking modes when the oven is off. It opens a menu with additional features if a cooking mode is already in process. You can exit the menu at any time by pressing the **Options** pad again.

You must first select a mode (bake, convection bake, convection roast) and then select Options to get to the following functions.

Cook Time

Counts down cooking time and turns off the oven when the cooking time is complete. Select a desired cooking mode. Use the number pads to program a baking temperature. Press the **Options** pad and select **Cook Time**. Use the number pad to program cook time in hours and minutes. Then press **Start/Enter**. This can only be used with Bake, Convection Bake, and Convection Roast.

NOTE: When using the Delay Time feature, foods that spoil easily – such as milk, eggs, fish, stuffing, poultry, and port – should not be allowed to sit for more than 1 hour before or after cooking. Room temperature promotes the growth of harmful bacteria. Be sure that the oven light is off because heat from the bulb will speed harmful bacteria growth.

Delay Time

Delays when the oven will turn on. Use this to set a time when you want the oven to start. Select a desired cooking mode. Use the number pad to program a baking temperature. Press the **Options** pad and select **Delay Time**. Use the number pads to program the time of day for the oven to turn on, and then press **Start/Enter**. Delay Time is not available with all modes.

Oven Probe

NOTE: Only accessible through traditional and convection cooking modes.

Monitors internal food temperature and turns the oven off when the food reaches the programmed temperature. Insert the probe, press the desired cooking mode, and program the probe temperature. See the Cooking Modes Section for more information. The probe can only be used with Bake, Convection Bake, and Convection Roast.

Settings

The **Options** and **Settings** pads open up more detailed menus in the display that allow access to additional functions. For each you select the function in the display using the associated number pad. You can exit at any time by pressing the **Options** or **Settings** pad again.

WiFi Connect and Remote Enable

Your oven is designed to provide you with two-way communication between your appliance and smart device. By using the WiFi Connect features, you will be able to control essential oven operations such as temperature settings, timers and cooking modes using your smartphone or tablet.*

Select **Settings** then **Wifi** - follow the instructions on your oven display and phone app. It is necessary to turn on WiFi before using Remote Enable on your oven.

Connecting your WiFi Connect Enabled Oven

What you will need

Your Café oven uses your existing home WiFi network to communicate between the appliance and your smart device. In order to setup your Café oven, you will need to gather some information:

1. Each Café oven has a connected appliance information label that includes an Appliance Network Name and Password. These are the two important details that you will need to connect to the appliance. The label is typically located inside the door of the oven or drawer.

Connected Appliance Information	
FCC: ZKJ-WCATA001	Network: GE_XXXXXX_XXXX
IC: 10229A-WCATA001	Password: XXXXXXXX
MAC ID: XX - XX - XX - XX - XX - XX	PT. NO. 229C6272G001-0

Sample Label

2. Have your smart phone or tablet ready with the ability to access the internet and download apps.
3. You will need to know the password of your home WiFi router. Have this password ready while you are setting up your Café oven.

Connect your Café oven

1. On your smart phone or tablet visit cafeappliances.com/connect to learn more about connected appliance features and to download the appropriate app.
2. Follow the app onscreen instructions to connect your Café oven.
3. Once the process is complete, the connection light located on your Café oven display will stay on solid and the app will confirm you are connected.

* Compatible Apple or Android devices and home WiFi network required.

Settings





WiFi Connect and Remote Enable (cont.)

- If the connection light does not turn on or is blinking, follow the instructions on the app to reconnect. If issues continue, please visit cafeappliances.com/connect and ask for assistance regarding oven wireless connectivity.

To connect additional smart devices, repeat steps 1 and 2.

Note that any changes or modifications to the remote enable device installed on this oven that are not expressly approved by the manufacturer could void the user's authority to operate the equipment.

REMOTE STARTING YOUR OVEN

To be able to start the oven remotely once connected to WiFi, select **Turn Remote On/Off** and the  icon will turn on in the display. The oven can now be remotely started with a connected device. The  icon must be lit to start the oven remotely. The  icon is not required to change the oven temperature while it is running, set a timer or to turn the oven off from the phone app while the  icon shows it is Wifi Connected.

After using the oven, remember to verify that the  icon is lit if you wish to start the oven remotely in the future.

NOTE: Foods that spoil easily—such as milk, eggs, fish, stuffings, poultry and pork—should not be allowed to sit for more than 1 hour before or after cooking. Room temperature promotes the growth of harmful bacteria. Be sure that the oven light is off because heat from the bulb will speed harmful bacteria growth.

Clock

This setting sets the oven clock time. Press the **Settings** pad and select **Clock**. Select **Set Clock** and follow the instructions to set the clock. This feature also specifies how the time of day will be displayed. You can select a standard 12-hour clock (12H), 24-hour military time display (24H), or no clock displayed (Off). Press the **Settings** pad, select **Set Clock** and select either **12/24 hr** or **On/Off**.

Bluetooth® - Chef Connect

This is a pairing feature for use with other compatible **Chef Connect** enabled products like an over-the-range microwave oven or range hood. To pair those products to the range Press the **Settings** pad and select **Bluetooth®**. Select **Pair** and follow the corresponding instructions included with the mating Chef Connect enabled product. The range will cancel pairing mode after two minutes if no mating device is detected. Select **Remove** to confirm product is paired or to un-pair from range. The Precision Cooking Probe can also be paired using the Bluetooth® feature.

Auto Conv (Auto Conversion)

When using Convection Bake and Convection Roast cooking, Auto Recipe Conversion will automatically convert the regular baking temperatures entered to convection bake cooking temperatures when turned on. Note that this option does not convert convection bake cooking times, it only converts temperatures. This feature may be turned On or Off. Select **Settings**, Auto Conversion is 5th option and shows up on first display of settings, and **Auto Conversion** then follow the prompts to turn this feature on or off.

Auto Off

This feature shuts the oven down after 12 hours of continuous operation. It may be enabled or disabled. Select **Settings**, **More**, and **Auto Off** to turn this feature on or off.

Sound

You can adjust the volume and type of alert your appliance uses. Select **Settings**, **More**, and **Sound**. Follow prompts for making volume adjustments or for changing between continuous and single alert tones. A continuous setting will continue to sound a tone until a button on the control is pressed. The oven tone volume can be adjusted. The control will sound the oven tone at the new volume level each time the sound level is changed.

F/C (Fahrenheit or Celsius)

The oven control is set to use Fahrenheit temperatures (F), but you can change it to use Celsius temperatures (C). Select **Settings**, **More**, and **F/C** to alter between temperature scales displayed.

Adjust the Oven temperature

This feature allows the oven baking and convection baking temperature to be adjusted up to 35°F hotter or down to 35°F cooler. Use this feature if you believe your oven temperature is too hot or too cold and wish to change it. This adjustment affects Bake and Convection Bake modes. Does not change Proof or Cleaning modes. Select **Settings** and **Oven Adjust** to add **More Heat** or **Less Heat** and then press **Save**.

Oven Info

Select **Settings**, **More**, and **Oven Info** to turn this feature on or off. This setting displays Model Number and Software Version.

Sabbath Mode

The Sabbath mode feature complies with standards set forth by Star K. Some of these standards that will be noticed by the consumer include the disabling of tones, disabling of oven lights, and delays of about 30 seconds to one minute on display changes. Only continuous baking or timed baking is allowed in the Sabbath mode. Cooking in the Sabbath mode is a two-step process, first the Sabbath mode must be set and then the bake mode must be set.

Setting the Sabbath Mode

Press the **Settings** pad, select **Sabbath**, and select **Turn on**. A single bracket “[” will appear in the display indicating that the Sabbath mode is set. The clock will not be displayed. Continuous bake or timed bake can now be programmed.

Starting a Continuous Bake

1. Press the **Bake** pad. (For double ovens, this operates the upper oven. If desiring to use Lower Oven, press **Lower Oven** and then **Bake**.)
2. If the desired temperature is 350F, press **Start/Enter**. If a different cooking temperature is desired, use the **1** through **5** number pads to select a preset cooking temperature, then press **Start/Enter**. Refer to the graphic below to determine which pad sets the desired cooking temperature.

After a delay, a second bracket “[” will appear in the display indicating that the oven is baking.

Temperature (°F)	1	2	3
	200	250	300
Time (hours)	4	5	6
	325	400	2h
	7	8	9
	2.5h	3h	3.5h
	Cancel Off	0	Start Enter Wake
		4h	

1 = 200° F, 2 = 250° F, 3 = 300° F, 4 = 325° F, 5 = 400° F

6 = 2 hours, 7 = 2.5 hours, 8 = 3 hours, 9 = 3.5 hours, 0 = 4 hours

Adjusting the Temperature

1. Press **Bake** (or press **Lower Oven** and then **Bake** for lower oven in a double oven unit), use the **1** through **5** number pads to select a different preset cooking temperature, and press **Start/Enter**.
2. Since no feedback is given during temperature change, an oven thermometer can be used to confirm temperature changes.

Starting a Timed Bake

1. Press the **Bake** pad.
2. If the desired temperature is 350F, use the **6** through **0** number pads to select a cooking time. If a cooking temperature other than 350F is desired, use the **1** through **5** number pads to select a preset cooking temperature, then select the cooking time. Refer to the graphic on this page to determine which pad sets the desired cooking temperature and cooking time.
3. Press **Start/Enter**.

After a delay, a second bracket “[” will appear in the display indicating that the oven is baking. When the cook time expires, the display will change back to a single bracket “[” indicating that the oven is no longer baking. No tone will sound when the cook time is complete.

Exit the Sabbath Mode

Exiting the Sabbath mode should be done after the Sabbath is over.

1. Press **Cancel/Off** to end any bake mode that may be running.
2. Press and hold **Settings** pad until **Sabbath Mode off** is displayed.

Sabbath Mode Power Outage Note

If a power outage occurs while the oven is in Sabbath Mode, the unit will return to Sabbath Mode when power is restored, however the oven will return to the off state even if it was in the middle of a bake cycle when the power outage occurred.

Oven Racks

Recommended rack positions for various types of foods are provided in the Cooking Guide. Adjusting rack position is one way to impact cooking results. For example, if you would prefer darker tops on cakes, muffins, or cookies, try moving food one rack position higher. If you find foods are too brown on top try moving them down next time.

When baking with multiple pans and on multiple racks, ensure there is at least 1½" between pans to allow sufficient space for air to flow.

Your Oven may have extension racks and/or traditional flat racks.

To avoid possible burns, place the racks in the desired position before you turn the oven on.

Extension Racks

Always pull the rack out by its upper front rail to its fully open position, when placing or removing cookware.

If extension racks are difficult to extend, lubricate the racks with the graphite lubricant provided with your oven. Remove the rack from the oven, remove debris in the side tracks with a paper towel, shake the graphite lubricant and place 4 small drops on the two bottom tracks of the left and right sides. Open and close the rack several times to distribute the lubricant.

To order additional graphite lubricant, see the Accessories and Consumer Support sections at the end of this manual.

To Remove An Extension Rack:

1. Make sure the rack is pushed all the way into the oven so that side paddles on the rack disengage from the oven support.
2. Slide the rack toward you to the bump (stop position) on the rack support.
3. Firmly grasp both sides of the rack frame and the sliding rack, tilt the front end up and pull it out.

To Replace An Extension Rack:

1. Firmly grasp both sides of the rack frame and the sliding rack.
2. Place the curved end of the rack (stop-locks) onto the oven supports, tilt up the front of the rack and push it in as far as it will go.

If extension racks are difficult to replace or remove, wipe the oven rack supports with cooking oil. Do not wipe oil on the rack slides.

To Lubricate the Paddle:

Shake lubricant and apply to the moving parts of the paddle mechanisms as shown.

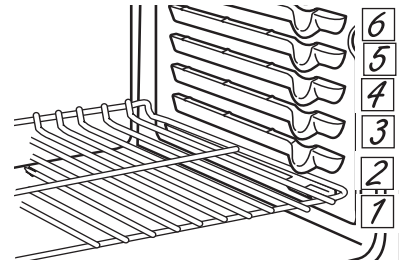

The number of rack positions may vary by model.

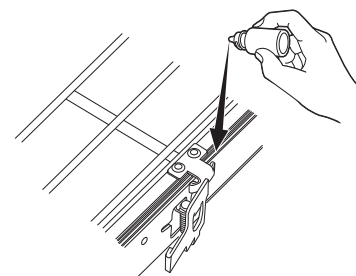
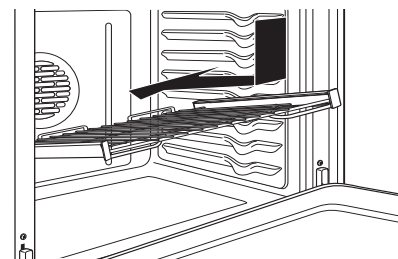
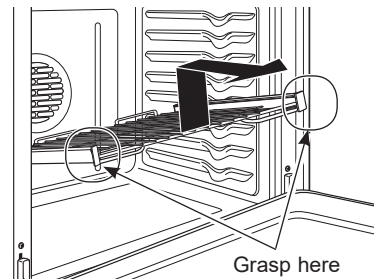
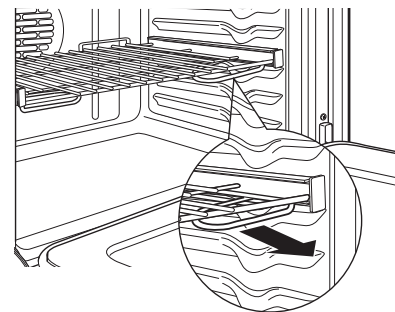
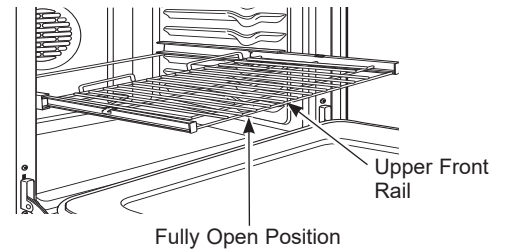

Aluminum Foil and Oven Liners

▲ CAUTION Do not use any type of foil or oven liner to cover the oven bottom. These items can trap heat or melt, resulting in damage to the product and risk of shock, smoke or fire. Damage from improper use of these items is not covered by the product warranty.

Foil may be used to catch spills by placing a sheet on a lower rack, several inches below the food. Do not use more foil than necessary and never entirely cover an oven rack with aluminum foil. Keep foil at least 1-1/2" from oven walls to prevent poor heat circulation.

Cookware

Cookware Guidelines

The material, finish, and size of cookware affect baking performance.

Dark, coated and dull pans absorb heat more readily than light, shiny pans. Pans that absorb heat more readily can result in a browner, crisper, and thicker crust. If using dark and coated cookware check food earlier than minimum cook time. If undesirable results are obtained with this type of cookware consider reducing oven temperature by 25°F next time.

Shiny pans can produce more evenly cooked baked goods such as cakes and cookies.

Glass and ceramic pans heat slowly but retain heat well. These types of pans work well for dishes such as pies and custards.

Air insulated pans heat slowly and can reduce bottom browning.

Keep cookware clean to promote even heating.

Cooking Modes

Your new oven has a variety of cooking modes to help you get the best results. These modes are described below. Refer to the Cooking Guide section for rack position and other recommendations for specific modes and foods.

Bake

The bake mode is for baking and roasting. When preparing baked goods such as cakes, cookies and pastries, always preheat the oven first. To use this mode press the **Bake** pad, enter a temperature with the number pads, and then press **Start/Enter**.

Warm

Warm mode is designed to keep hot foods hot. Cover foods that need to remain moist and do not cover foods that should be crisp. Preheating is not required. Do not use warm to heat cold food. It is recommended that food not be kept warm for more than 2 hours. Press the **Warm** pad and then press **Start/Enter**.

Some models may also have warming drawers. Three settings are available - use High for items such as stews, meats, and potatoes; use Medium for items such as casseroles and pizzas; use Low for items such as breads, waffles, and also for warming oven-safe dishes.

Broiling Modes

Always broil with the oven door/drawer closed. Monitor food closely while broiling. Use caution when broiling; placing food close to the broil element or burner increases smoking, spattering and the possibility of fats igniting. It is not necessary to preheat when using the Broil modes.

Broil Hi

The Broil High mode uses intense heat from the upper element or burner to sear foods. Use Broil High for thinner cuts of meat and/or when you would like to have a seared surface and rare interior. To use this mode press the **Broil** pad once and then press **Start/Enter**.

Broil Lo

The Broil Low mode uses less intense heat from the upper element or burner to cook food thoroughly while also browning the surface. Use Broil Low for thicker cuts of meat and/or foods that you would like cooked all the way through. To use this mode press the **Broil** pad twice and then press **Start/Enter**.

Cooking Modes (Cont.)

Frozen Snacks

The Frozen Snacks modes are designed to cook frozen foods such as potato nuggets, French fries, and similar frozen snacks and appetizers. Most foods will cook within package recommended time. Adjust cooking time according to individual preferences.

Use Frozen Snacks Single when cooking frozen snacks on a single rack. This mode does not require preheating the oven. Food should be placed in the oven before or immediately upon starting this mode.

Use Frozen Snacks Multi when cooking frozen snacks on two racks simultaneously. This mode includes a preheating cycle to prepare the oven for multi-rack baking. Press **Options** and select **Frozen** then follow any display prompts to access this mode.

Frozen Pizza

The Frozen Pizza modes are designed to cook frozen pizzas. Most pizzas will cook within package recommended times. Adjust cooking time according to individual preferences.

Use Frozen Pizza Single when cooking on a single rack. This mode does not require preheating the oven. Food should be placed in the oven before or immediately upon starting this mode.

Use Frozen Pizza Multi when cooking on two racks simultaneously. This mode includes a preheating cycle to prepare the oven for multi-rack baking. Press **Options** and select **Frozen** then follow any display prompts to access this mode.

Baked Goods

The Baked Goods mode is designed for cooking cakes, breads, cookies, and similar foods on a single rack. This mode is designed to provide lighter top browning and better volume. Some foods may require slightly longer cook times relative to when cooked in the traditional bake mode. Press **Options** and select **Baked Goods** then follow any display prompts to access this mode.

Convection Bake Multi Rack

The Convection Bake mode is intended for baking on multiple racks at the same time. This mode uses air movement from the convection fan to enhance cooking evenness. Your oven is equipped with Auto Recipe Conversion, so it is not necessary to adjust the temperature when using this mode. Always preheat when using this mode. Baking times may be slightly longer for multiple racks than what would be expected for a single rack. To use this mode press the **Conv Bake** pad, enter a temperature with number pads, and then press **Start/Enter**.

Convection Roast

The Convection Roast mode is intended for roasting whole cuts of meat on a single rack. This mode uses air movement from the convection fan to improve browning and reduce cooking time. Check food earlier than the recipe suggested time when using this mode, or use the probe (see the Probe section for more information). It is not necessary to preheat when using this mode. To use this mode press the **Conv Roast** pad, enter a temperature with the number pads, and then press **Start/Enter**.

Proof

Proof mode maintains a warm environment for rising yeast-leavened dough. If the oven is too warm, Proof mode will not operate and the display will show "Oven too hot for Proof". For best results, cover the dough while proofing and check early to avoid over-proofing.

▲ CAUTION

Do not use the Proof mode for warming food or keeping food hot. The proofing oven temperature is not hot enough to hold foods at safe temperatures.

Oven Probe

▲WARNING Consuming undercooked food can result in foodborne illness. Use probe according to the following instructions to ensure all portions of the food reach minimum safe cooking temperatures. Recommendations for minimum safe food temperatures can be found at foodsafety.gov or IsItDoneYet.gov.

Internal food temperature is frequently used as an indicator of doneness, especially for roasts and poultry. The Probe mode monitors the internal food temperature and turns the oven off when the internal food temperature reaches the programmed temperature.

Always check the temperature at multiple locations in the food with a food thermometer after cooking to ensure that all portions of the food have reached the minimum safe internal temperature for that food.

Proper Probe Placement

After preparing the meat and placing it on the cooking pan follow these instructions for proper probe placement.

- Insert the probe into the food, so that the tip of the probe will rest in the center of the thickest part of the food. For best performance the probe should be fully inserted into the food. If the probe is not located properly, it may not accurately measure the temperature of the coolest portion of the food. Some foods, particularly small items, are not well suited for cooking with the probe due to their shape or size.
- The probe should not touch bone, fat or gristle.
- For whole poultry insert the probe into the thickest part of the breast.
- For boneless roasts, insert the probe into the center of the roast.
- For bone-in ham or lamb, insert the probe into the center of the lowest large muscle or joint.
- For casseroles or dishes such as meatloaf, insert the probe into the center of the dish.
- For fish, insert the probe from just above the gill into the meatiest area, parallel to the backbone.

Probe Usage

The temperature probe can only be used with Bake, Convection Bake, and Convection Roast.

To use the probe with preheating:

1. Select the desired cook mode (**Bake**, **Convection Bake**, or **Convection Roast**) pad and enter the desired cooking temperature with the number pads.
2. Insert the probe into the food (see Proper Probe Placement).

3. Once the oven is preheated, place the food in the oven and connect the probe to the probe outlet, making sure it is fully inserted. Use caution, the oven walls and probe outlet are hot.
4. When the probe is connected, the display will prompt you to enter the desired food temperature. The maximum internal food temperature that you can set is 200° F.

To use the probe without preheating:

1. Insert the probe into the food (see Proper Probe Placement).
2. Place the food in the oven and connect the probe into the probe outlet in the oven.
3. Press the **Cook Mode** pad (**Traditional Bake**, **Convection Bake**, or **Convection Roast**) and enter the desired cooking temperature with the number pads. Press **Options** and select **Probe** then follow the display prompts to enter the desired food temperature.

Probe Care Guidelines

- Use of probes other than the one provided with this product may result in damage to the probe outlet.
- Use the handles of the probe and plug when inserting and removing them from the meat and outlet
- To avoid damaging your probe, do not use tongs to pull on the cable when removing it.
- To avoid breaking the probe, make sure food is completely defrosted before inserting the probe.
- To prevent possible burns, do not unplug the probe from the outlet until the oven has cooled.
- Never leave the probe inside the oven during a self or steam clean cycle.
- Do not store the probe in the oven.

Cooking Guide

FOOD TYPE	RECOMMENDED MODE(S)	RECOMMENDED RACK POSITION(S)	ADDITIONAL SUGGESTIONS
Baked Goods			
Layer cakes, sheet cakes, bundt cakes, muffins, quick breads on a Single Rack	Bake Bake Goods	3	Use shiny cookware.
Layer cakes* on Multiple Racks	Bake Convection Bake	2 ext and 5 flat	Use shiny cookware. Ensure adequate airflow (see illustration below).
Chiffon cakes (angel food)	Bake Bake Goods	1	Use shiny cookware.
Cookies, biscuits, scones on a Single Rack	Bake Bake Goods	3	Use shiny cookware.
Cookies, biscuits, scones on Multiple Racks	Convection Bake	2 ext and 5 flat 1 flat, 3 flat, 5 ext	Use shiny cookware. Ensure adequate airflow.
Yeast Breads	Proof	2 or 3	Cover dough loosely.
	Bake Bake Goods	3	
Beef & Pork			
Hamburgers	Broil High	6 flat	Use a broil pan; move food down for more doneness/less searing. Watch food closely when broiling. For best performance center food below the broil heater.
Steaks & Chops	Broil High	6 flat or 5 ext	Use a broil pan; move food down for more doneness/less searing. Watch food closely when broiling. For best performance center food below the broil heater.
Roasts	Bake Convection Roast	2 or 3	Use a low sided pan such as a broil pan. Preheating is not necessary.
Poultry			
Whole chicken	Bake Convection Roast	2 or 3	Use a low sided pan such as a broil pan. Preheating is not necessary.
Bone-in chicken breasts, legs, thighs	Broil Low Bake	3	If breaded or coated in sauce avoid Broil High modes. Broil skin side down first. Watch food closely when broiling. For best performance when broiling, center food below the broil heater.
Boneless chicken breasts	Broil Low Bake	3	Move food down for more doneness/less searing and up for greater searing/browning when broiling. For best performance when broiling, center food below the broil element or burner.
Whole turkey	Bake Convection Roast	1	Use a low sided pan such as a broil pan. Preheating is not necessary.
Turkey Breast	Bake Convection Roast	3	Use a low sided pan such as a broil pan. Preheating is not necessary.
Fish	Broil Low	6 (1/2 inch thick or less) 5 (>1/2 inch)	Watch food closely when broiling. For best performance center food below the broil heater.
Casseroles	Bake	3 or 4	
Frozen Convenience Foods			
Pizza on a Single Rack	Frozen Pizza Single	3	Place food in oven prior to starting mode.
Pizza on Multiple Racks	Frozen Pizza Multi	2 ext and 5 flat	Stagger pizzas left to right, do not place directly over each other.
Potato products, chicken nuggets, appetizers on a Single Rack	Frozen Snacks Single	4 or 5	Place food in oven prior to starting mode. Use dark cookware for more browning/crisping; use shiny cookware for less browning.
Potato products, chicken nuggets, appetizers on Multiple Racks	Frozen Snacks Multi	2 ext and 5 flat	Use dark cookware for more browning/crisping; use shiny cookware for less browning.

*When baking four cake layers at a time use racks 2 ext and 5 flat. Place the pans as shown so that one pan is not directly above another.

Cook food thoroughly to help protect against food borne illness. Minimum safe food temperature recommendations for food safety can be found at IsItDoneYet.gov. Make sure to use a food thermometer to take food temperatures.

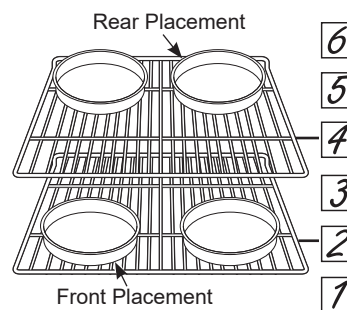

Rack positions

Cleaning the Range – Exterior

Be sure all controls are off and all surfaces are cool before cleaning any part of the range.



⚠ WARNING

If your range is removed for cleaning, servicing or any reason, be sure the anti-tip device is reengaged properly when the range is replaced. Failure to take this precaution could result in tipping of the range and can result in death or serious burns to children or adults.

Control Lockout

If desired, the touch pads may be deactivated before cleaning.

See Lock Controls in the Oven Controls section in this manual.

Clean up splatters with a damp cloth.

You may also use a glass cleaner.

Remove heavier soil with warm, soapy water. Do not use abrasives of any kind.

Reactivate the touch pads after cleaning.

Control Panel

It's a good idea to wipe the control panel after each use. Clean with mild soap and water or vinegar and water, rinse with clean water and polish dry with a soft cloth.

Do not use abrasive cleansers, strong liquid cleansers, plastic scouring pads or oven cleaners on the control panel—they will damage the finish, including Black Stainless Steel.

Oven Exterior

Do not use oven cleaners, abrasive cleansers, strong liquid cleansers, steel wool, plastic scouring pads, or cleaning powders on the interior or exterior of the oven. Clean with a mild soap and water or vinegar and water solution. Rinse with clean water and dry with a soft cloth. When cleaning surfaces, make sure that they are at room temperature and not in direct sunlight.

If stain on the door vent trim is persistent, use a mild abrasive cleaner and a sponge-scrubber for best results.

Spillage of marinades, fruit juices, tomato sauces and basting liquids containing acids may cause discoloration and should be wiped up immediately. Let hot surfaces cool, then clean and rinse.

Painted Surfaces

Painted surfaces include the sides of the range and the door, top of control panel and the drawer front. Clean these with soap and water or a vinegar and water solution.

Do not use commercial oven cleaners, cleaning powders, steel wool or harsh abrasives on any painted surface, including Black Stainless Steel.

Stainless Steel excluding Black Stainless Steel (on some models)

Do not use a steel wool pad; it will scratch the surface.

Cleaners with oxalic acid such as Bar Keepers Friend Soft Cleanser™ will remove surface rust, tarnish and small blemishes. Use only a liquid cleanser free of grit and rub in the direction of the brush lines with a damp, soft sponge.

To clean the stainless steel surface, use warm sudsy water or a stainless steel cleaner or polish. Always wipe the surface in the direction of the grain. Follow the cleaner instructions for cleaning the stainless steel surface.

To inquire about purchasing cleaning products including stainless steel appliance cleaner or polish, see the Accessories and Consumer Support sections at the end of this manual.

Cleaning the Range – Interior

The interior of your new oven can be cleaned manually or by using Steam Clean or Self Clean modes.

Spillage of marinades, fruit juices, tomato sauces and basting liquids containing acids may cause discoloration and should be wiped up immediately. Let hot surfaces cool, then clean and rinse.

Manual Cleaning

Do not use oven cleaners, strong liquid cleansers, steel wool, or scouring pads on the interior of the oven. For soils on the oven bottom and other enameled surfaces, use a gentle abrasive containing oxalic acid, such as Bar Keepers Friend®, with a non-scratch sponge. Take care not to apply any abrasive cleaners or sponges to

the door glass, as it will scratch the reflective coating. The oven interior and door glass may be cleaned using a soft cloth with a mild soap and water, or vinegar and water solution. After cleaning, rinse with clean water and dry with a soft cloth.

Steam Clean Mode

The Steam Clean feature is for cleaning light soil from your oven at a lower temperature than Self Clean.

To use the Steam Clean feature:

1. Start with the oven at room temperature.
2. Wipe excess grease and soils from the oven.
3. Pour one cup of water onto the bottom of the oven.
4. Close the door.

5. Press the **Clean** pad, select **Steam Clean** and then press **Start/Enter**.

You cannot open the door during the 30 minute Steam Clean cycle. At the end of the Steam Clean cycle, soak up the remaining water, and wipe the moisture-softened soil from the oven walls and door.

Self Clean Mode

Read Self-Cleaning Oven Safety Instructions at the beginning of this manual before using the Self Clean Mode. Self Clean uses very high temperatures to clean the oven interior. For a moderately soiled oven, run a 3 hour self-clean cycle. For a heavily soiled oven, run a 5 hour self-clean cycle. Only self-clean (black) racks and grates may remain in the oven during the self-clean cycle. All other items, including nickel plated (silver) racks, should be removed. If nickel plated (silver) racks are left in the oven during a self-clean cycle, the racks will tarnish. If either type of rack is left in the oven during a self-clean cycle, the rack may become difficult to slide. See the Oven Racks section for instructions on how to improve.

IMPORTANT: The health of some birds is extremely sensitive to the fumes given off during the self-cleaning cycle of any range. Move birds to another well-ventilated room.

To use the Self Clean feature:

1. Start with the oven at room temperature.
2. Wipe excess grease and soils from the oven and interior door.
3. Remove all items other than self-clean (black) racks and grates, if desired. See Cleaning the Cooktop to determine if your grates may be self-cleaned and for important details regarding grate placement.

4. Close the door.
5. Press the **Clean** pad, select **Self Clean** and then press **Start/Enter**.

You cannot open the door during the self-clean cycle. The door will remain locked after the self-clean cycle until the oven cools below the unlocking temperature. At the end of the self-clean cycle, allow the oven to cool and wipe any ash out of the oven.

To Stop a Self-Clean Cycle

Press the Cancel/Off pad. Wait until the oven has cooled below the locking temperature to unlatch the door. You will not be able to open the door right away unless the oven has cooled below the locking temperature.

On Some Models:

The surface units are automatically disabled during the self-clean cycle. Make sure that all surface unit controls are turned off at all times during the self-clean cycle.

Wait until the self-clean cycle is finished to set and use the surface units.

Racks

All racks can be washed with warm, soapy water. Enameled (not shiny) racks can be left in the cavity during self clean.

Racks may be more difficult to slide, especially after a self-clean. Put some vegetable oil on a soft cloth or paper towel and rub onto the left and right edges.

Cleaning the Range – Interior (Cont.)

Oven Heating Elements

Do not clean the bake element or the broil element. Any soil will burn off when the elements are heated. The bake element is not exposed and is under the oven floor. Clean the oven floor with warm, soapy water.

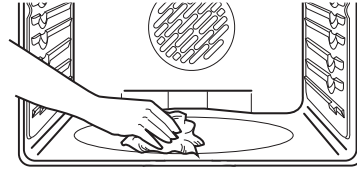

Wipe up heavy soil on the oven bottom.

Cleaning the Glass Cooktop

Normal Daily Use Cleaning

ONLY use CERAMA BRYTE® Ceramic Cooktop Cleaner on the glass cooktop. Other creams may not be as effective.

To maintain and protect the surface of your glass cooktop, follow these steps:

1. Before using the cooktop for the first time, clean it with CERAMA BRYTE® Ceramic Cooktop Cleaner. This helps protect the top and makes cleanup easier.
2. Daily use of CERAMA BRYTE® Ceramic Cooktop Cleaner will help keep the cooktop looking new.
3. Shake the cleaning cream well. Apply a few drops of CERAMA BRYTE® Ceramic Cooktop Cleaner directly to the cooktop.

4. Use a paper towel or CERAMA BRYTE® Cleaning Pad for Ceramic Cooktops to clean the entire cooktop surface.
5. Use a dry cloth or paper towel to remove all cleaning residue. No need to rinse.



Clean your cooktop after each spill. Use CERAMA BRYTE® Ceramic Cooktop Cleaner.

NOTE: It is very important that you DO NOT heat the cooktop until it has been cleaned thoroughly.

Burned-On Residue

NOTE: DAMAGE to your glass surface may occur if you use scrub pads other than those recommended.

1. Allow the cooktop to cool.
2. Spread a few drops of CERAMA BRYTE® Ceramic Cooktop Cleaner on the entire burned residue area.
3. Using the included CERAMA BRYTE® Cleaning Pad for Ceramic Cooktops, rub the residue area, applying pressure as needed.
4. If any residue remains, repeat the steps listed above as needed.

5. For additional protection, after all residue has been removed, polish the entire surface with CERAMA BRYTE® Ceramic Cooktop Cleaner and a paper towel.

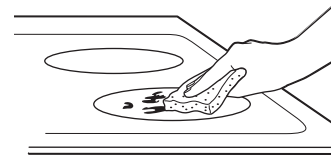

Use a CERAMA BRYTE® Cleaning Pad for Ceramic Cooktops.

Heavy, Burned-On Residue

1. Allow the cooktop to cool.
2. Use a single-edge razor blade scraper at approximately a 45° angle against the glass surface and scrape the soil. It will be necessary to apply pressure to the razor scraper in order to remove the residue.
3. After scraping with the razor scraper, spread a few drops of CERAMA BRYTE® Ceramic Cooktop Cleaner on the entire burned residue area. Use the CERAMA BRYTE® Cleaning Pad to remove any remaining residue.
4. For additional protection, after all residue has been removed, polish the entire surface with CERAMA BRYTE® Ceramic Cooktop Cleaner and a paper towel.

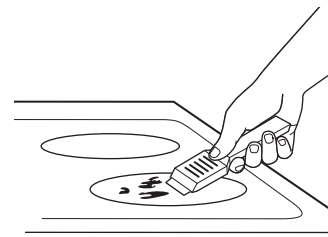

The CERAMA BRYTE® Ceramic Cooktop Scraper and all recommended supplies are available through our Parts Center. See the Accessories and Consumer Support sections at the end of this manual.

NOTE: Do not use a dull or nicked blade.

Cleaning the Glass Cooktop (Cont.)

Metal Marks and Scratches

1. Be careful not to slide pots and pans across your cooktop. It will leave metal markings on the cooktop surface.

These marks are removable using the CERAMA BRYTE® Ceramic Cooktop Cleaner with the CERAMA BRYTE® Cleaning Pad for Ceramic Cooktops.

2. If pots with a thin overlay of aluminum or copper are allowed to boil dry, the overlay may leave black discoloration on the cooktop.

This should be removed immediately before heating again or the discoloration may be permanent.

NOTE: Carefully check the bottom of pans for roughness that would scratch the cooktop.

Damage from Sugary Spills and Melted Plastic

Special care should be taken when removing hot substances **to avoid permanent damage of the glass surface**. Sugary spillovers (such as jellies, fudge, candy, syrups) or melted plastics can cause pitting of the surface of your cooktop (not covered by the warranty) unless the spill is removed while still hot. Special care should be taken when removing hot substances.

Be sure to use a new, sharp razor scraper.

Do not use a dull or nicked blade.

1. Turn off all surface units. Remove hot pans.

2. Wearing an oven mitt:

- a. Use a single-edge razor blade scraper to move the spill to a cool area on the cooktop.
- b. Remove the spill with paper towels.

3. Any remaining spillover should be left until the surface of the cooktop has cooled.

4. Don't use the surface units again until all of the residue has been completely removed.

NOTE: If pitting or indentation in the glass surface has already occurred, the cooktop glass will have to be replaced. In this case, service will be necessary.

Oven Probe

The temperature probe may be cleaned with soap and water or a soap-filled scouring pad. Cool the temperature probe before cleaning. Scour stubborn spots with a soap-filled scouring pad, rinse and dry.

To order additional temperature probes, see the Accessories and Consumer Support sections at the end of this manual.

- Do not immerse the temperature probe in water.
- Do not store the temperature probe in the oven.
- Do not leave the temperature probe inside the oven during a self or steam clean cycle.

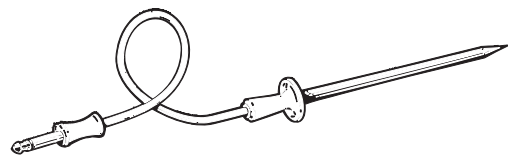

Drawer

Removable Warming Drawer

NOTE: For models with an electric warming drawer, before performing any adjustments, cleaning or service, disconnect the range electrical power supply at the household distribution panel by removing the fuse or switching off the circuit breaker. Make sure the warming drawer heating element is cool.

Most cleaning can be done with the drawer in place. However, the drawer may be removed if further cleaning is needed. Use soap and warm water to thoroughly clean.

To remove the drawer:

1. Pull drawer straight out until it stops.
2. Press the left rail release up and press the right rail release down, while pulling the drawer forward and free.

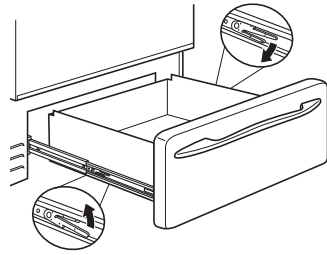

To replace the drawer:

1. Place the left drawer rail around the inner left rail guide and slide it in slightly to hook it.
2. Place the right drawer rail around the inner right rail guide and slide it in slightly to hook it.
3. Slide the drawer all the way in.

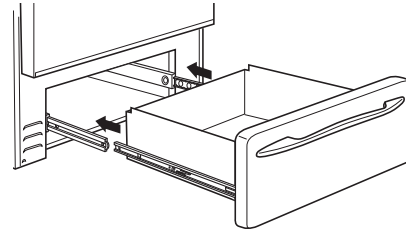

Oven Light

⚠ WARNING SHOCK OR BURN HAZARD: Before replacing oven light bulb, disconnect the electrical power to the range at the main fuse or circuit breaker panel. Failure to do so may result in electric shock or burn.

⚠ CAUTION BURN HAZARD: The glass cover and bulb should be removed when cool. Touching hot glass with bare hands or a damp cloth can cause burns.

NOTE: The glass cover should be removed only when cold. Wearing latex gloves may offer a better grip. Before replacing the bulb, disconnect electrical power to the oven at the main fuse or circuit breaker panel. Let the bulb cool completely before removing it. For your safety do not touch a hot bulb with a damp cloth. If you do the bulb may break.

To remove:

Turn the glass cover counterclockwise 1/4 turn until the tabs of the glass cover clear the grooves of the socket and pull the cover off. Remove the bulb.

To replace:

Put in a new 40-watt appliance bulb. Place the tabs of the glass cover into the grooves of the socket. Turn the glass cover clockwise 1/4 turn.

NOTE:

- A 40-watt appliance bulb is smaller than a standard 40-watt household bulb.
- Reconnect electrical power to the oven once the new bulb is installed.
- For improved lighting inside the oven, clean the glass cover frequently using a wet cloth. This should be done when the oven is completely cool.

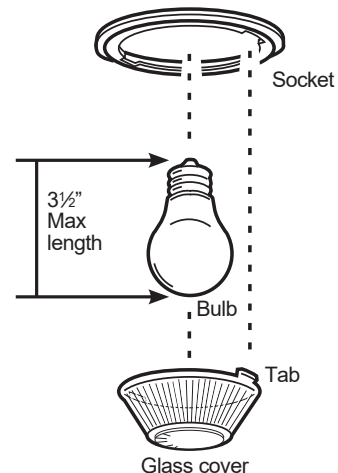

Oven Door

The door is very heavy. Be careful when removing and lifting the door. Do not lift door by the handle.

To Remove the Door:

1. Fully open the door.
2. Pull the hinge locks up and away from the range frame to the unlocked position.
3. Firmly grasp both sides of the door near the top.
4. Close door until the top of the door is approximately 6" from the range frame.
5. Lift door up and away from the range until both hinge arms are clear of the slots in the range frame.

To Replace the Door:

1. Firmly grasp both sides of the door near the top.
2. With the door at the same angle as the removal position, rest the notch on the underside of the left hinge arm on the bottom edge of the left hinge slot. The notch in the hinge arm must be fully seated into the bottom of the slot. Repeat for the right side.
3. Fully open the door. If the door will not fully open, the notches in the bottoms of the hinge arms have not seated correctly in the bottom edge of the slot. Lift the door off the range and repeat previous step.
4. Push the hinge locks toward the range cavity and down to the locked position.
5. Close the oven door.

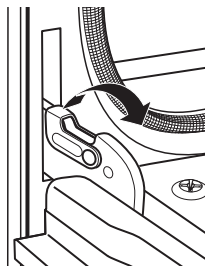

Pull hinge locks up to unlock

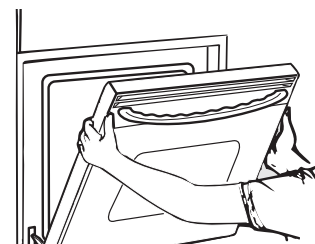

Removal position

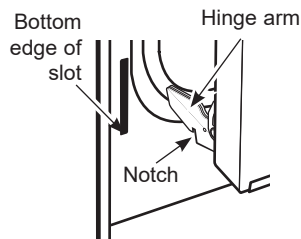

Rest notch on bottom edge of hinge slot

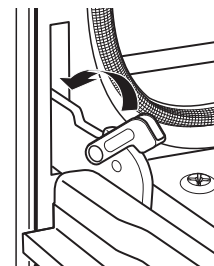

Push hinge locks down to lock

Troubleshooting tips ... Before you schedule service

Save time and money! Review the charts on the following pages first and you may not need to schedule service.

Problem	Possible Cause	What To Do
Surface units do not work properly or flashing power setting.	Pan not positioned correctly.	Center the pan in the cooking zone.
	Pan is not in full contact with glass surface.	Pan must be flat.
	In some areas, the power (voltage) may be low.	Cover pan with a lid until desired heat is obtained.
	A fuse in your home may be blown or the circuit breaker tripped.	Replace the fuse or reset the circuit breaker.
	Cooktop controls improperly set.	Check to see that the control is set properly. Press On then + or -
Surface unit setting changed or turned off unexpectedly.	High cooktop temperature.	Allow the internal fan to cool the cooktop. Check if pan boiled dry.
Scratches (may appear as cracks) on cooktop glass surface.	Incorrect cleaning methods being used.	Scratches are not removable. Tiny scratches will become less visible in time as a result of cleaning.
	Cookware with rough bottoms being used or coarse particles (salt or sand) were between the cookware and the surface of the cooktop. Cookware has been slid across the cooktop surface.	To avoid scratches, use the recommended cleaning procedures. Make sure bottoms of cookware are clean before use, and use cookware with smooth bottoms.
Areas of discoloration on the cooktop.	Food spillovers not cleaned before next use.	See the Cleaning the glass cooktop section.
	Hot surface on a model with a light-colored cooktop.	This is normal. The surface may appear discolored when it is hot. This is temporary and will disappear as the glass cools.
Plastic melted to the surface.	Hot cooktop came into contact with plastic placed on the hot cooktop.	See the Glass surface—potential for permanent damage section in the Cleaning the glass cooktop section.
Pitting (or indentation) of the cooktop.	Hot sugar mixture spilled on the cooktop.	Call a qualified technician for replacement.
My new oven doesn't cook like my old one. Is something wrong with the temperature settings?	Your new oven has a different cooking system from your old oven and therefore may cook differently than your old oven.	For the first few uses, follow your recipe times and temperatures carefully. If you still think your new oven is too hot or too cold, you can adjust the temperature yourself to meet your specific cooking preference. NOTE: This adjustment affects Bake, and Convection Bake temperatures; it will not affect Broil or Clean.
Food does not bake properly.	Oven controls improperly set.	See the Cooking Modes section.
	Rack position is incorrect or rack is not level.	See the Cooking Modes section and Cooking Guide.
	Incorrect cookware or cookware of improper size being used.	See the Cookware section.
	Oven temperature needs adjustment.	See the Special Features section.
	Ingredient substitution.	Substituting ingredients can change the recipe outcome.
Food does not broil properly.	Oven controls improperly set.	Make sure you select the appropriate broil mode.
	Improper rack position being used.	See Cooking Guide for rack location suggestions.
	Food being cooked in a hot pan.	Make sure cookware is cool.
	Cookware not suited for broiling.	Use a pan specifically designed for broiling.
	The probe is plugged into the outlet in the oven.	Unplug and remove the probe from the oven.
	Aluminum foil used on the broiling pan and grid has not been fitted properly and slit as recommended.	If using aluminum foil conform to pan slits.
	In some areas the power (voltage) may be low.	Preheat the broil element for 10 minutes.
Oven temperature too hot or too cold.	Oven temperature needs adjustment.	See the Special Features section.

Troubleshooting tips ... Before you schedule service

Problem	Possible Cause	What To Do
Oven does not work or appears not to work.	Plug on range is not completely inserted in the electrical outlet.	Make sure electrical plug is plugged into a live, properly grounded outlet.
	A fuse in your home may be blown or the circuit breaker tripped.	Replace the fuse or reset the circuit breaker.
	Oven controls improperly set.	See the Using the Oven section.
	Oven is in Sabbath Mode.	Verify, that the oven is not in Sabbath Mode. See the Special Features section.
“Crackling” or “popping” sound.	This is the sound of the metal heating and cooling during both the cooking and cleaning functions.	This is normal.
Why is my range making a “clicking” noise when using my oven?	Your range cycles the heating elements by turning relays on and off to maintain the oven temperature.	This is normal.
Clock and timer do not work.	A fuse in your home may be blown or the circuit breaker tripped.	Replace the fuse or reset the circuit breaker.
	Plug on range is not completely inserted in the electrical outlet.	Make sure electrical plug is plugged into a live, properly grounded outlet.
	Oven controls improperly set.	See the Using the kitchen timer section.
Oven door is crooked.	The door is out of position.	Because the oven door is removable, it sometimes gets out of position during installation. To straighten the door, re-install the door. See the “Lift-Off Oven Door” instructions in the “Care and Cleaning” section.
Oven light does not work.	Light bulb is loose or defective.	Tighten or replace bulb.
	Pad operating light is broken.	Call for service.
Oven will not self-clean.	The temperature is too high to set a self-clean operation.	Allow the oven to cool and reset the controls.
	Oven controls improperly set.	See the Cleaning the Oven section.
	The probe is plugged into the outlet in the oven.	Remove the probe from the oven.
Oven will not steam clean.	Display flashes HOT.	Allow the oven to cool to room temperature and reset the controls.
	Oven controls improperly set.	See the Using Steam Clean section.
	Oven door is not closed.	Make sure you close the door to start steam clean cycle.
Excessive smoking during clean cycle.	Excessive soil or grease.	Press the Cancel/Off pad. Open the windows to rid the room of smoke. Wait until the LOCKED light goes off. Wipe up the excess soil and reset the clean cycle.
Excessive smoking during broiling.	Food too close to burner element.	Lower the rack position of the food.
Oven door will not open after a clean cycle.	Oven too hot.	Allow the oven to cool below locking temperature.
Oven not clean after a clean cycle.	Oven controls improperly set.	See the Cleaning the Oven section.
	Oven was heavily soiled.	Clean up heavy spillovers before starting the clean cycle. Heavily soiled ovens may need to self-clean again or for a longer period of time.
“LOCK DOOR” flashes in the display.	The self-clean cycle has been selected but the door is not closed.	Close the oven door.
DOOR LOCK light is on when you want to cook.	The oven door is locked because the temperature inside the oven has not dropped below the locking temperature.	Press the Cancel/Off pad. Allow the oven to cool.
“F— and a number or letter” flash in the display.	You have a function error code.	Press the Cancel/Off pad. Allow the oven to cool for one hour. Put the oven back into operation.
	If the function code repeats.	Disconnect all power to the oven for at least 30 seconds and then reconnect power. If the function error code repeats, visit cafeappliances.com/service .
Display goes blank.	A fuse in your home may be blown or the circuit breaker tripped.	Replace the fuse or reset the circuit breaker.
	The clock is turned off.	See the Special features section.
Oven or cooktop will not stay set.	Function error.	Disconnect all power for at least 30 seconds and then reconnect power. If repeating, visit cafeappliances.com/service .

Troubleshooting tips ... Before you schedule service

Problem	Possible Cause	What To Do
Power outage, clock flashes.	Power outage or surge.	Reset the clock. If the oven was in use, you must reset it by pressing the Cancel/Off pad, setting the clock and resetting any cooking function.
“Burning” or “oily” odor emitting from the vent.	This is normal in a new oven and will disappear in time.	To speed the process, set a self-clean cycle for a minimum of 3 hours. See the Cleaning the Oven section.
Strong odor.	An odor from the insulation around the inside of the oven is normal for the first few times the oven is used.	This is temporary and will go away after several uses or a self-clean cycle.
Fan noise.	A convection fan may automatically turn on and off.	This is normal. The fan is designed to operate intermittently to maximize cooking evenness. The convection fan will operate during preheat of the bake cycle. The fan will turn off after the oven is heated to the set temperature. This is normal.
	A cooling fan may automatically turn on and off.	This is normal. The cooling fan will turn off and on to cool internal parts. It may run after the oven is turned off.
My oven door glass appears to be “tinted” or have a “rainbow” color. Is this defective?	No. The inner oven glass is coated with a heat barrier to reflect the heat back into the oven to prevent heat loss and keep the outer door cool while baking.	This is normal. Under certain light or angles, you may see this tint or rainbow color.
Sometimes the oven takes longer to preheat to the same temperature.	Cookware or food in oven.	The cookware or food in the oven will cause the oven to take longer to preheat. Remove items to reduce preheat time.
	Number of racks in oven.	Adding more racks to the oven will cause the oven to take longer to preheat. Remove some racks.
	Different cooking modes.	The different cooking modes use different preheat methods to heat the oven for the specific cooking mode. Some modes will take longer than others (i.e. convection bake).
Display flashes.	Power failure.	Reset the clock.
Control signals after entering cooking time or start time.	You forgot to enter a bake temperature or cleaning time.	Touch the Bake pad and desired temperature or the Self Clean pad and desired clean time.
Oven racks are difficult to slide.	The shiny, silver-colored racks were cleaned in a self-clean cycle.	Apply a small amount of vegetable oil to a paper towel and wipe the edges of the oven racks with the paper towel. Do not spray with Pam® or other lubricant sprays.
Steam from the vent.	When using the ovens, it is normal to see steam coming out of the oven vents. As the number of racks or amount of food being cooked increases, the amount of visible steam will increase.	This is normal.
Warming drawer will not work.	A fuse in your home may be blown or the circuit breaker tripped.	Replace the fuse or reset the circuit breaker.
	Controls improperly set.	See the Using the warming drawer section.
Excessive condensation in the drawer.	Liquid in drawer.	Remove liquid.
	Uncovered foods.	Cover food with lid or aluminum foil.
	Temperature setting too high.	Reduce temperature setting.
Food dries out in the warming drawer.	Moisture escaping.	Cover food with lid or aluminum foil.
	Drawer not fully closed.	Push drawer in until latch engages.
Water remaining on oven floor after Steam Clean cycle.	This is normal.	Remove any remaining water with a dry cloth or sponge.
“Probe” appears in the display.	This is reminding you to enter a probe temperature after plugging in the probe.	Enter a probe temperature.

Café Electric Range Warranty

cafeappliances.com

All warranty service is provided by our Factory Service Centers, or an authorized service technician. To schedule service online, visit us at cafeappliances.com/service. Please have your serial number and your model number available when scheduling service.

Servicing your appliance may require the use of the onboard data port for diagnostics. This gives a Café factory service technician the ability to quickly diagnose any issues with your appliance and helps Café improve its products by providing Café with information on your appliance. If you do not want your appliance data to be sent to Café, please advise your technician not to submit the data to Café at the time of service.

For the period of	Café will replace
One year From the date of the original purchase	Any part of the range which fails due to a defect in materials or workmanship. During this limited one-year warranty , Café will provide, free of charge , all labor and in-home service to replace the defective part.

What Café will not cover:

- Service trips to your home to teach you how to use the product.
- Improper installation, delivery or maintenance.
- Failure of the product if it is abused, misused, modified or used for other than the intended purpose or used commercially.
- Damage to the glass cooktop caused by use of cleaners other than the recommended cleaning creams and pads.
- Damage to the glass cooktop caused by hardened spills of sugary materials or melted plastic that are not cleaned according to the directions in the Owner's Manual.
- Replacement of house fuses or resetting of circuit breakers.
- Damage to the product caused by accident, fire, floods or acts of God.
- Damage to finish, such as surface rust, tarnish, or small blemishes not reported within 48 hours of delivery.
- Incidental or consequential damage caused by possible defects with this appliance.
- Damage caused after delivery.
- Product not accessible to provide required service.
- Service to repair or replace light bulbs, except for LED lamps.

Staple your receipt here. Proof of the original purchase date is needed to obtain service under the warranty.

EXCLUSION OF IMPLIED WARRANTIES

Your sole and exclusive remedy is product repair as provided in this Limited Warranty. Any implied warranties, including the implied warranties of merchantability or fitness for a particular purpose, are limited to one year or the shortest period allowed by law.

This limited warranty is extended to the original purchaser and any succeeding owner for products purchased for home use within the USA. If the product is located in an area where service by a Café Authorized Servicer is not available, you may be responsible for a trip charge or you may be required to bring the product to an Authorized Café Service location for service. In Alaska, the limited warranty excludes the cost of shipping or service calls to your home. Some states do not allow the exclusion or limitation of incidental or consequential damages. This limited warranty gives you specific legal rights, and you may also have other rights which vary from state to state. To know what your legal rights are, consult your local or state consumer affairs office or your state's Attorney General.

Warrantor: GE Appliances, a Haier company

Louisville, KY 40225

Extended Warranties: Purchase a Café extended warranty and learn about special discounts that are available while your warranty is still in effect. You can purchase it online anytime at

cafeappliances.com/extended-warranty

Café Service will still be there after your warranty expires.

Accessories

Looking For Something More?

Café offers a variety of accessories to improve your cooking and maintenance experiences!

Refer to the Consumer Support page for website information.

The following products and more are available:

Accessories

Front Control Knobs and Handles

Small Broiler Pan (8 ¾" x 1 ¼" x 13 ½")

Large Broiler Pan (12 ¾" x 1 ¼" x 16 ½")

XL Broiler Pan (17" x 1 ¼" x 19 1/4")

Parts

Oven racks

Oven elements

Light bulbs

Cleaning Supplies

CitruShine™ Stainless Steel Wipes

CERAMA BRYTE® Stainless Steel Appliance Cleaner

CERAMA BRYTE® Cleaning Pads for Ceramic Cooktops

CERAMA BRYTE® Ceramic Cooktop Cleaner

CERAMA BRYTE® Ceramic Cooktop Scraper

Kit (Kit includes cream and cooktop scraper)

*The large broiler pan does not fit in 20"/24" ranges.

** The XL broiler pan does not fit in 24" wall ovens, 27" drop-ins or 20"/24" range.

Consumer Support

Café Website

Have a question or need assistance with your appliance? Try the Café website 24 hours a day, any day of the year! You can also shop for more great Café products and take advantage of all our on-line support services designed for your convenience. In the US: cafeappliances.com

Register Your Appliance

Register your new appliance on-line at your convenience! Timely product registration will allow for enhanced communication and prompt service under the terms of your warranty, should the need arise. You may also mail in the pre-printed registration card included in the packing material. In the US: cafeappliances.com/register

Schedule Service

Expert Café repair service is only one step away from your door. Get on-line and schedule your service at your convenience any day of the year. In the US: cafeappliances.com/service

Extended Warranties

Purchase a Café extended warranty and learn about special discounts that are available while your warranty is still in effect. You can purchase it on-line anytime. Café Service will still be there after your warranty expires. In the US: cafeappliances.com/extended-warranty

Remote Connectivity

For assistance with wireless network connectivity (for models with remote enable), visit our website at cafeappliances.com/connect

Parts and Accessories

Individuals qualified to service their own appliances can have parts or accessories sent directly to their homes (VISA, MasterCard and Discover cards are accepted). Order on-line today 24 hours every day. In the US: cafeappliances.com/parts

Instructions contained in this manual cover procedures to be performed by any user. Other servicing generally should be referred to qualified service personnel. Caution must be exercised, since improper servicing may cause unsafe operation.

Contact Us

If you are not satisfied with the service you receive from Café, contact us on our website with all the details including your phone number, or write to:

In the US: General Manager, Customer Relations | Café Appliances, Appliance Park | Louisville, KY 40225
cafeappliances.com/contact